



ROTADOCK

Turn your boardroom into a state of the art meeting place with the sleek Rotadock!

ROTADOCK

The Rotadock is rotated open by hand and features a rare locking mechanism to secure the unit in both the open and closed position. This manual boardroom solution can be customized to suit any office environment.

The Rotadock makes this high quality product range accessible to all. Take the opportunity to upgrade your office with this unique and affordable boardroom solution.



2 x UK individually fused | 2 x data points | Cut-out dimensions 281x115mm

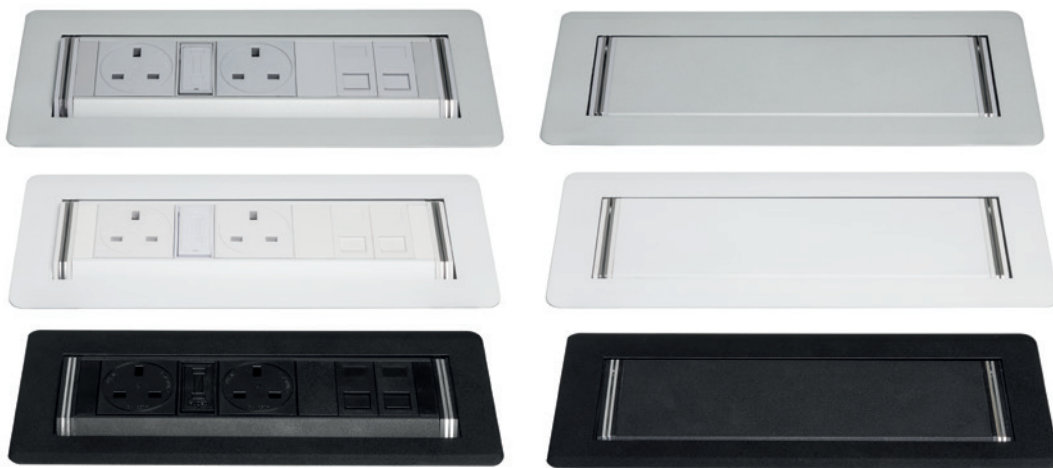

- ROT203-15B552** Cat5e 2m
ROT203-15B553 Cat5e 3m
ROT203-15B555 Cat5e 5m
ROT203-15B662 Cat6 2m
ROT203-15B663 Cat6 3m
ROT203-15B665 Cat6 5m
- ROT203-12B552** Cat5e 2m
ROT203-12B553 Cat5e 3m
ROT203-12B555 Cat5e 5m
ROT203-12B662 Cat6 2m
ROT203-12B663 Cat6 3m
ROT203-12B665 Cat6 5m
- ROT203-11B552** Cat5e 2m
ROT203-11B553 Cat5e 3m
ROT203-11B555 Cat5e 5m
ROT203-11B662 Cat6 2m
ROT203-11B663 Cat6 3m
ROT203-11B665 Cat6 5m

2 x UK individually fused | 2 x data points with Smart Charge USB | Cut-out dimensions 331x115mm



- ROT2S3-15B552** Cat5e 2m
ROT2S3-15B553 Cat5e 3m
ROT2S3-15B555 Cat5e 5m
ROT2S3-15B562 Cat6 2m
ROT2S3-15B563 Cat6 3m
ROT2S3-15B565 Cat6 5m
- ROT2S3-12B552** Cat5e 2m
ROT2S3-12B553 Cat5e 2m
ROT2S3-12B555 Cat5e 2m
ROT2S3-12B562 Cat6 2m
ROT2S3-12B563 Cat6 3m
ROT2S3-12B565 Cat6 5m
- ROT2S3-11B552** Cat5e 2m
ROT2S3-11B553 Cat5e 2m
ROT2S3-11B555 Cat5e 2m
ROT2S3-11B562 Cat6 2m
ROT2S3-11B563 Cat6 3m
ROT2S3-11B565 Cat6 5m

2 x UK individually fused | 2 x data points | 1 x HDMI, SVGA & 3.5mm Audio | Cut-out dimensions 331x115mm



- ROT205-1555HSA2 CAT5e 2m
- ROT205-1555HSA3 CAT5e 3m
- ROT205-1555HSA5 CAT5e 5m
- ROT205-1566HSA2 CAT6 2m
- ROT205-1566HSA3 CAT6 3m
- ROT205-1566HSA5 CAT6 5m
- ROT205-1255HSA2 CAT5e 2m
- ROT205-1255HSA3 CAT5e 3m
- ROT205-1255HSA5 CAT5e 5m
- ROT205-1266HSA2 CAT6 2m
- ROT205-1266HSA3 CAT6 3m
- ROT205-1266HSA5 CAT6 5m
- ROT205-1155HSA2 CAT5e 2m
- ROT205-1155HSA3 CAT5e 3m
- ROT205-1155HSA5 CAT5e 5m
- ROT205-1166HSA2 CAT6 2m
- ROT205-1166HSA3 CAT6 3m
- ROT205-1166HSA5 CAT6 5m

3 x UK individually fused | 3 x data points | Cut-out dimensions 331x115mm



- ROT303-1552 CAT5e 2m
- ROT303-1553 CAT5e 3m
- ROT303-1555 CAT5e 5m
- ROT303-1562 CAT6 2m
- ROT303-1563 CAT6 3m
- ROT303-1565 CAT6 5m
- ROT303-1252 CAT5e 2m
- ROT303-1253 CAT5e 3m
- ROT303-1255 CAT5e 5m
- ROT303-1262 CAT6 2m
- ROT303-1263 CAT6 3m
- ROT303-1265 CAT6 5m
- ROT303-1152 CAT5e 2m
- ROT303-1153 CAT5e 3m
- ROT303-1155 CAT5e 5m
- ROT303-1162 CAT6 2m
- ROT303-1163 CAT6 3m
- ROT303-1165 CAT6 5m

4 x UK individually fused | 4 x data point | Cut-out dimensions 406x115mm



- ROT404-1552 CAT5e 2m
- ROT404-1553 CAT5e 3m
- ROT404-1555 CAT5e 5m
- ROT404-1562 CAT6 2m
- ROT404-1563 CAT6 3m
- ROT404-1565 CAT6 5m
- ROT404-1252 CAT5e 2m
- ROT404-1253 CAT5e 3m
- ROT404-1255 CAT5e 5m
- ROT404-1262 CAT6 2m
- ROT404-1263 CAT6 3m
- ROT404-1265 CAT6 5m
- ROT404-1152 CAT5e 2m
- ROT404-1153 CAT5e 3m
- ROT404-1155 CAT5e 5m
- ROT404-1162 CAT6 2m
- ROT404-1163 CAT6 3m
- ROT404-1165 CAT6 5m

2 x UK individually fused | 2 x data | SVGA & 3.5mm Audio | Silver/Grey | Cut-out dimensions 390x115mm



ROT2S3-AO-1155HSA2 CAT5e 2m
ROT2S3-AO-1155HSA3 CAT5e 3m
ROT2S3-AO-1155HSA5 CAT5e 5m

ROT2S3-AO-1166HSA2 CAT6 2m
ROT2S3-AO-1166HSA3 CAT6 3m
ROT2S3-AO-1166HSA5 CAT6 5m

OPTIONS

POWER LOGIC are the recognised market leader throughout the world. As such we can supply all our power products with a vast range of approved international power sockets. (full details in the technical brochure).

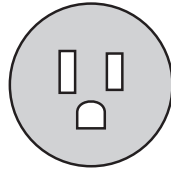

USA

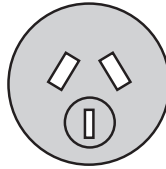

CHINA/AUSTRALIA

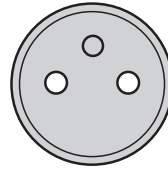

FRANCE/BELGIUM

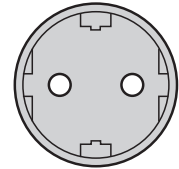

SCHUKO

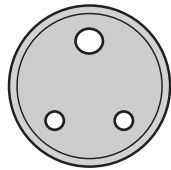

INDIA

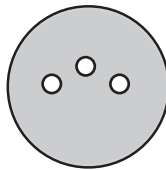

SWITZERLAND

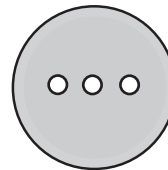

ITALY

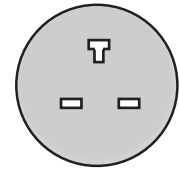

UK 'T'

We stock a vast range of Data and AV interfaces that can be fitted within the Rotadock range (full details in the technical brochure). We also stock the associated cables in lengths from 1 to 10 metres.

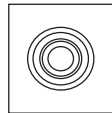

AUDIO

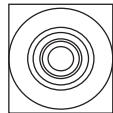

RCA

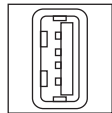

USB

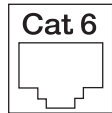

DATA



HDMI

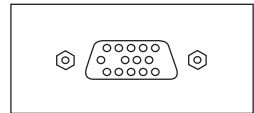

VGA

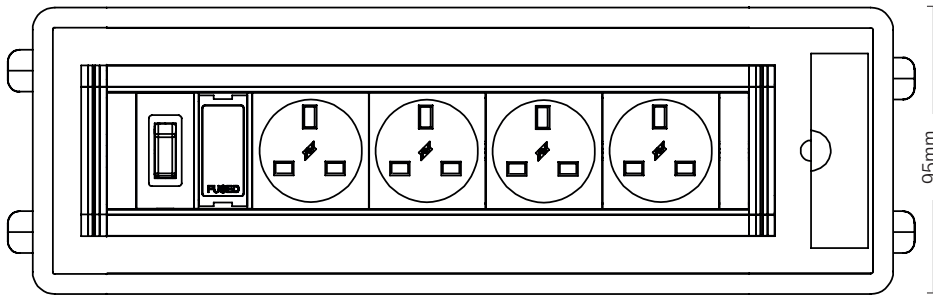

95mm

COMMS MODULE

The comms module houses two peripherals and can be fitted on one or both ends. Peripherals can also be fitted in the main body of the unit

EASY INSTALLATION

Four ratchet clips quickly and easily slide on to fasten the unit in its mounting cutout.

RAISED INTERFACE

The unit is raised above the mounted surface to reduce spilt fluid ingress when in the open position.

FLUSH MOUNTING

When closed, the unit sits almost flush with the work surface to minimize obstruction.

ELECTRICAL

Operating Voltage: 220V-250V @ 50 Hz, 110V-125V AC @ 60 Hz, Current: 15A.
 Max Power: 1800W @ 110V-125V AC, 3000W @ 220V-250V AC

DIMENSIONS

Width: 55mm (approx. 4 1/2")
 Length: Determined by configuration
 Height: (Open) 107mm (approx. 4 1/2")

WORK SURFACE THICKNESS

10mm - 50mm (approx. 2/5" - 2")

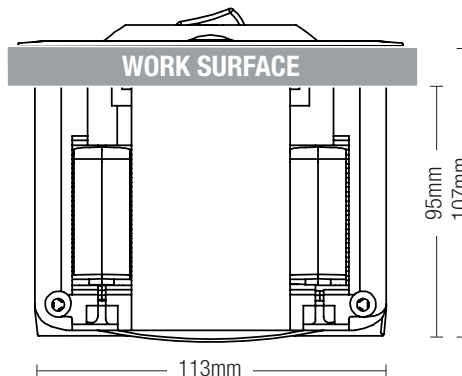

95mm
107mm

113mm