



ONE TOUCH

Power at the touch of your fingertips with the One-Touch's LED touch sensors that activate the German-engineered motor and rotate the unit to reveal the power outlets. Turn your boardroom into a state-of-the-art meeting place with the sleek One-Touch!

ONE TOUCH

The One Touch rotation is activated by touch sensitive LED sensors at each end to both the open and closed position. This High end boardroom solution can be customized to suit any office environment.

The One Touch makes this high quality product range accessible to all. Take the opportunity to upgrade your office with this unique boardroom solution.

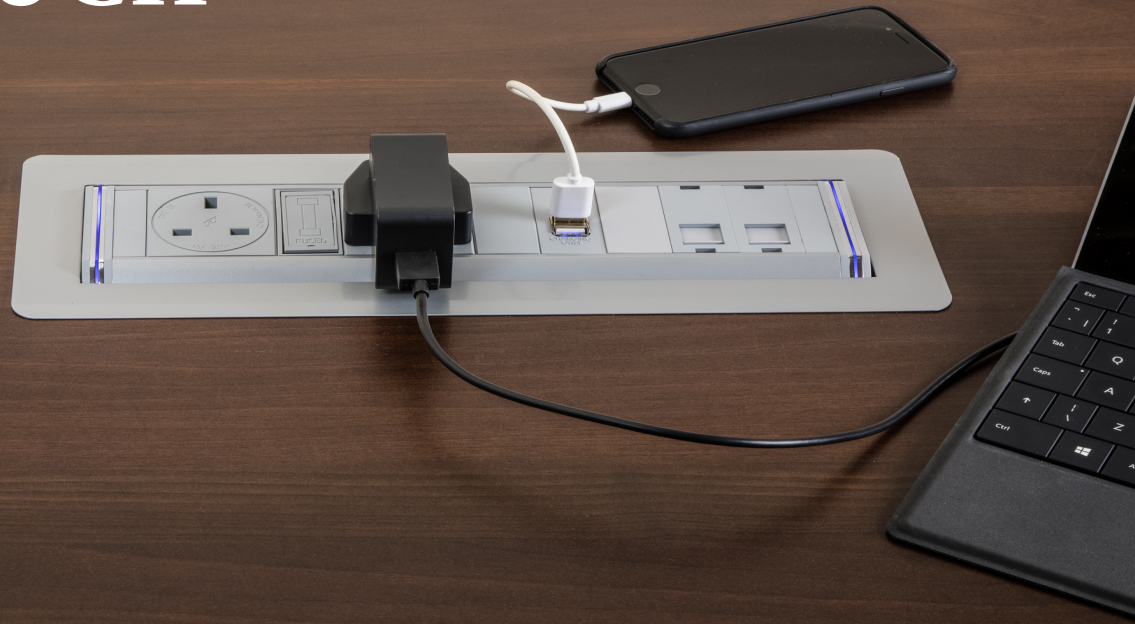

2 x UK individually fused | 2 x data points with Smart Charge USB | Cut-out dimensions 331x115mm

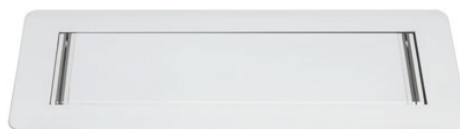

OTE2C3-11B552 Cat5e 2m
OTE2C3-11B553 Cat5e 3m

OTE2C3-11B662 Cat6 2m
OTE2C3-11B663 Cat6 3m

OTE2C3-15B552 Cat5e 2m
OTE2C3-15B553 Cat5e 3m

OTE2C3-15B662 Cat6 2m
OTE2C3-15B663 Cat6 3m

OTE2C3-12B552 Cat5e 2m
OTE2C3-12B553 Cat5e 3m

OTE2C3-12B662 Cat6 2m
OTE2C3-12B663 Cat6 3m

2 x UK individually fused | 2 x data points & HDMI with Smart Charge USB | Cut-out dimensions 331x115mm

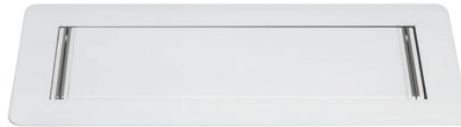

OTE2C3-11B552 Cat5e 2m
OTE2C3-11B553 Cat5e 3m

OTE2C3-11B662 Cat6 2m
OTE2C3-11B663 Cat6 3m

OTE2C3-15B552 Cat5e 2m
OTE2C3-15B553 Cat5e 3m

OTE2C3-15B662 Cat6 2m
OTE2C3-15B663 Cat6 3m

OTE2C3-12B552 Cat5e 2m
OTE2C3-12B553 Cat5e 3m

OTE2C3-12B662 Cat6 2m
OTE2C3-12B663 Cat6 3m

2 x UK individually fused | 2 x data | HDMI, SVGA & 3.5mm Audio | Silver/Grey | Cut-out dimensions 390x115mm



OTE2C3-AO-1155HSA2 Cat5e 2m
OTE2C3-AO-1155HSA3 Cat5e 3m

OTE2C3-AO-1166HSA2 Cat6 2m
OTE2C3-AO-1166HSA3 Cat6 3m

POWER LOGIC are the recognised market leader throughout the world. As such we can supply all our power products with a vast range of approved international power sockets. (full details in the technical brochure).

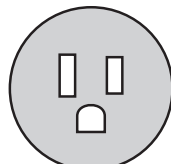

USA

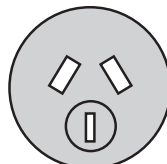

CHINA/AUSTRALIA

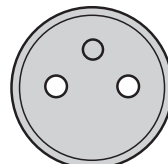

FRANCE/BELGIUM

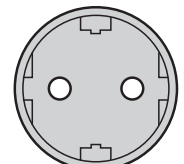

SCHUKO

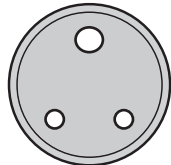

INDIA

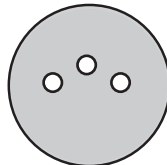

SWITZERLAND

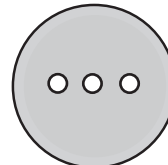

ITALY

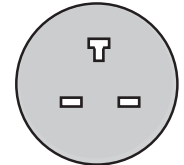

UK 'T'

We stock a vast range of Data and AV interfaces that can be fitted within the Rotadock range (full details in the technical brochure). We also stock the associated cables in lengths from 1 to 10 metres.

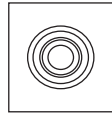

AUDIO

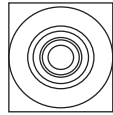

RCA

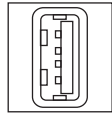

USB

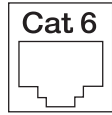

DATA



HDMI

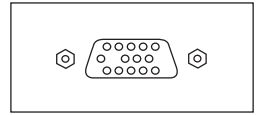

VGA

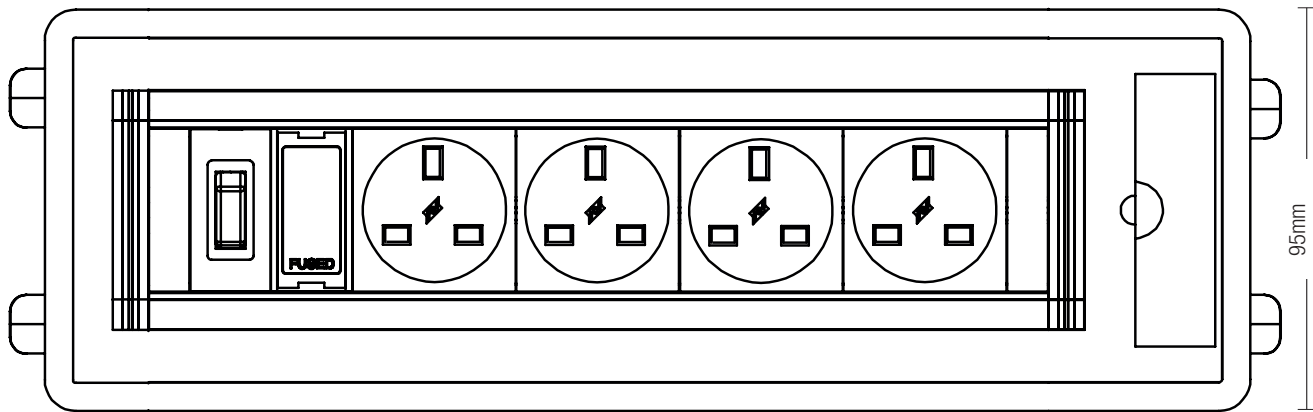

95mm

COMMS MODULE

The comms module houses two peripherals and can be fitted on one or both ends. Peripherals can also be fitted in the main body of the unit

EASY INSTALLATION

Four ratchet clips quickly sand easily slide on to fasten the unit in its mounting cutout.

RAISED INTERFACE

The unit is raised above the mounted surface to reduce spill fluid ingress when in the open position.

FLUSH MOUNTING

When closed, the unit sits almost flush with the work surface to minimize obstruction.

ELECTRICAL

Operating Voltage: 220V-250V @ 50 Hz
 110V-125V AC @ 60 Hz
 Current: 15A
 Max Power: 1800W @ 110V-125V AC
 3000W @ 220V- 250V AC

WORK SURFACE

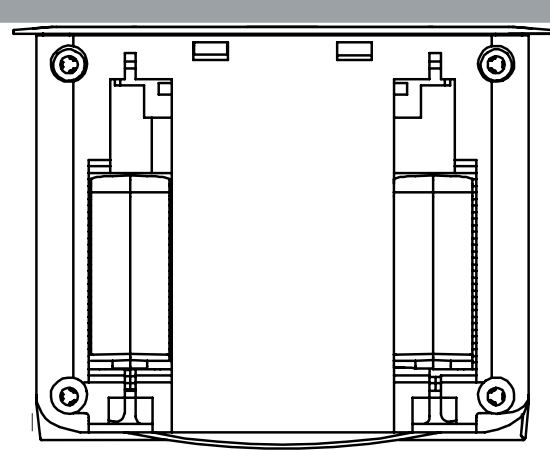

95mm

107mm

113mm

DIMENSIONS

Width: 55mm (approx. 4 1/2")
 Length: Determined by configuration
 Height: (Open) 107mm (approx. 4 1/2")

WORK SURFACE THICKNESS

10mm - 50mm (approx. 2/5" - 2")